

Measure what you see.

Automatchic Vision



A member of  **ALTANA**

 **BYK**
Additives & Instruments

Automatchic Vision

Manual

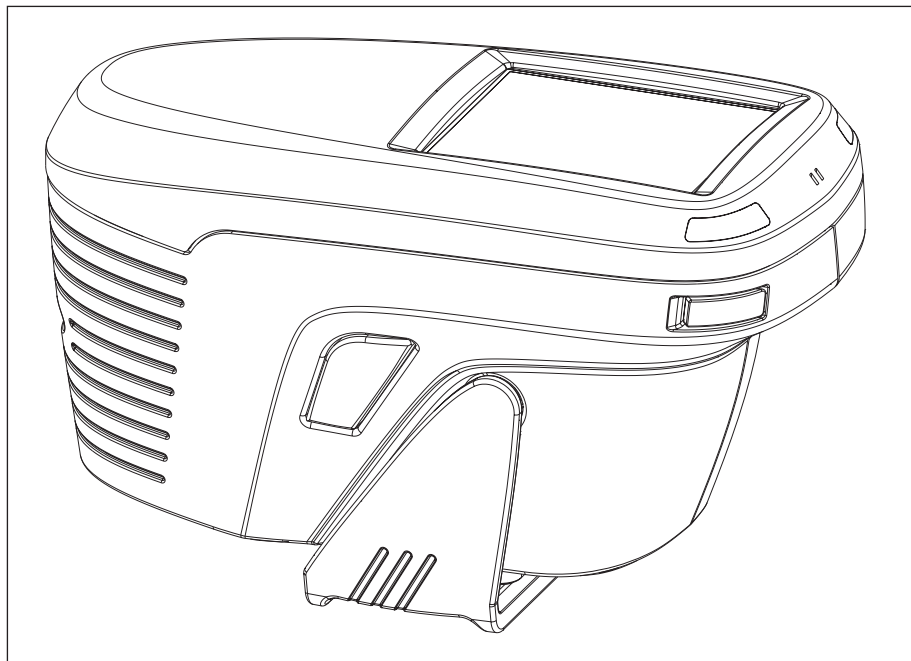

Patent pending

275 023 070 E 1409

BYK - Gardner GmbH
Lausitzer Straße 8
82538 Geretsried
Germany
Tel. 0-800-gardner
(0-800-4273637)
+49- 8171-3493-0
Fax +49- 8171-3493-140

BYK - Gardner USA
9104 Guilford Road
Columbia, MD 21046
USA
Phone 800-343-7721
301-483-6500
Fax 800-394-8215
301-483-6555

www.byk.com/instruments

Dear customer,
thank you for having decided for a BYK-Gardner product. BYK-Gardner is committed to providing you with quality products and services. We offer complete system solutions to solve your problems in areas of color, appearance and physical properties. As the basis of our worldwide business, we strongly believe in total customer satisfaction. Therefore, in addition to our products, we offer many VALUE-ADDED services:

- Technical Sales Force
- Technical & Application Support
- Application and Technical Seminars
- Repair & Certification Service

BYK-Gardner is part of Altana AG and a direct subsidiary of BYK-Chemie GmbH, a leading supplier of additives for coatings and plastics. Together, we offer complete and unique solutions for you, our customer.

Thank you for your trust and confidence. If there is anything we can do better to serve your needs, do not hesitate to let us know.

Your BYK-Gardner Team

Contents

1. Safety instructions	5
2. System description and Delivery notes	10
3. Power supply	12
4. Controls.....	13
5. Getting started.....	14
6. Calibrate	16
7. Measurement techniques	20
7.1 Light protection ring	20
7.2 Cleaning the Car.....	21
8. Measurement	23
8.1 Measuring the vehicle.....	23
8.2 Rotating during measurements	23
8.3 Measurement-Step-by-Step.....	25
8.4 Add coarseness (optional)	27
8.5 Add Car Make (optional)	28
8.6 Delet readings.....	29
9 Setup	30
9.1 Device Info	30
9.2 WLAN settings.....	31
9.3 Auto measure.....	32
9.4 Beeper	32
9.5 Display background	32
9.6 Rotate display.....	32
9.7 Language.....	33
9.8 Run Diagnosis	33

10. Interface	34
11. Standards	35
12. Technical Data	36
13. Errors and Warning Messages.....	37
15. Cleaning and Maintenance	39
15.1 Cleaning standards	39
15.2 Light protection ring	40
16. Copyright	41

- Avoid prolonged high relative humidity and do not allow condensation water.
- **Do not use any acetone or other aggressive or strong solvents for cleaning the unit!** The unit housing is resistant to many solvents. For cleaning you should use a soft, moist cloth. Excessive dirt and dust can be removed with ethanol or cleaning alcohol.

Additional information on use:

- You will find the technical data for all system components such as the measurement unit and battery compartment on the respective manufacturer's plates and in the section Technical Data



- Rechargeable batteries are special waste and must therefore not be disposed of with household trash. Make certain to observe the disposal instructions of the battery or rechargeable battery manufacturer. Insulate the terminals of the batteries with adhesive tape or similar materials before disposal.

2. System description and Delivery notes

The three-angle (25°, 45°, 110°) spectrophotometer is a custom instrument for use with the Akzo Nobel software. The instrument is an easy to use tool for measuring the color of automotive paint finishes and storing the information for uploading data to the AkzoNobel Color Retrieval Software.

The instrument is operated by the Operate button and the touch screen display. The Operate button is used to switch on the instrument and execute a reading. On the touch screen display you can select icons and functions directly.

The instrument can be configured in different languages.

The instrument complies with the following standards: DIN 5033, 5036, 6174, 6175-2; ISO 7724; ASTM D2244, E308, E1164, E2194, SAE J 1545.

Automatchic Vision

7060

Comes complete with:

Measurement device with protective clamp, combined standard white and green, USB interface cable, external power supply with plug set (EU, USA, UK, AUS), Li-ion battery pack, hand strap, seal replacement set, stylus, protective display film, carrying case, operating manual on CD.

Accessories and spare parts

Stylus	275022667
Protective clamp	275023086
Protective display film	275023150
Seal replacement set (including one light protection rubber seal and three rubber pin covers)	275023152
USB interface cable	100900588
Hand strap	100803719
External power supply	100900470
Plug set (EU, USA, UK, AUS)	100900471

3. Power supply

Before operating the instrument the first time, read the operating instructions and pay attention to the safety instructions in Section 1.

To operate the instrument, the battery must be charged first.

Connect the external power supply with the instrument and the power outlet.

The charging process is indicated by the green bars in the upper right corner of the instrument.

It is only allowed to charge the instrument with the power supply supplied by the instrument manufacturer.

Please make sure to charge the batteries latest after 5 months. The temperature range over which the batterie can be charged is 0° C to 45° C (32° F to 113° F).

4. Controls

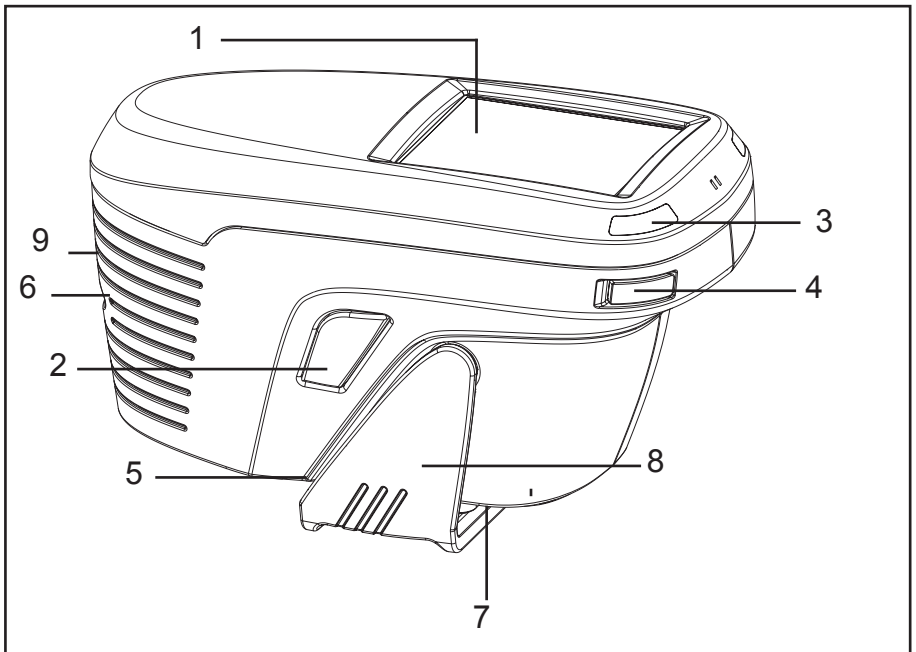

Measurement unit

- 1 Display for user guidance
- 2 Operate button (measurement button): switch on and measure
- 3 Indicator lights
- 4 Stylus
- 5 Alignment mark
- 6 USB-Interface for charging or connecting to a PC
- 7 Pins to detect correct placement during measurement procedure
- 8 Protective clamp
- 9 Hand strap ring

5. Getting started

Turning on the unit

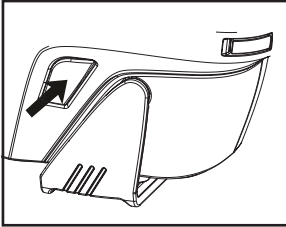

To turn the unit on, press the operate button.



The main menu appears.

Navigation

The operate button and the touch screen are used to control the system. Pressing the operate button turns the unit on and executes a reading. All settings within the menu are made by direct navigation on the touch screen.

Touching the corresponding field on the touch screen performs the selected functions.

System operation is supported by comments and error messages, which appear on the display.

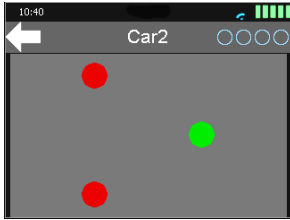

To ensure stable positioning, the instrument is equipped with 3 trigger pins on the bottom plate. If not all pins have been pressed thoroughly on the sample surface (e.g. curvature too high, instrument movement), the display shows the pins which are not pressed correctly in red and the indication lights are red.

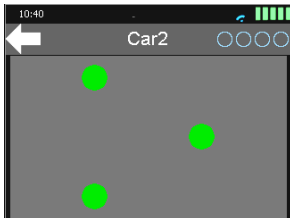

Press all pins correctly on the sample surface. The pins on the display and the indication lights turn green.

6. Calibrate

Standards

The instrument comes with 2 standards. One white standard and a green standard. White calibration is requested every 30 days, green tile check every 7 days.

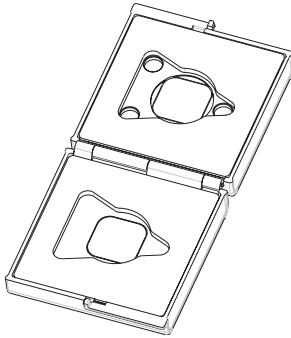

White and green standard are fixed in one case, hinged together. The white standard is used to perform the 100% reflectance calibration. The green standard is supplied to audit instrument performance.



A red exclamation mark beside the calibration tile symbol indicates that white calibration or green tile check are required.

Both white and green standard tiles are device serial number specific and can only be replaced by the instrument manufacturer.

Calibration Notes

- Dirt or dust in the optics of the instrument will cause an inaccurate calibration reading. Therefore, always use the protective clamp, if no readings are taken.
- The standards should be cleaned periodically. For cleaning procedure see section „Cleaning and Maintenance“. Please make sure that the standards are not scratched.
- Do not move the instrument while taking a calibration measurement. If motion is detected, an error message will be displayed and calibration is aborted.
- When moving from cold to warm environment, there is a danger of condensation. For this reason, you should wait for an appropriate amount of time to allow the optical components to adjust before calibrating and using the unit.

6.1 Calibrate

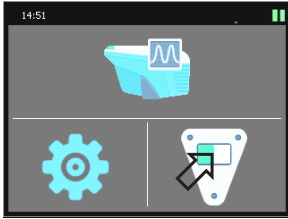

Press the calibration tile symbol on the display.



The number of days until the next calibration is required are indicated.

When clicking on the white tile symbol, a complete white and green calibration will be performed.

When clicking on the green tile symbol, only a green calibration will be performed.

Complete calibration:

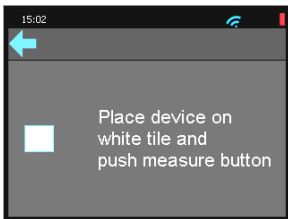

Click on the white tile symbol. A message is displayed.



Open the standard box and position the instrument on the white standard. The instrument snaps into the indentation of the standard and can only be positioned in one direction.

Press the operate button.

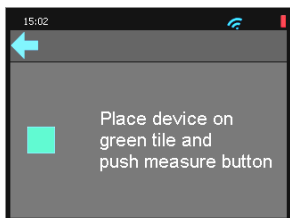

After the white calibration has been performed, the instrument indicates that the green standard is required.

Place the instrument on the green standard and press the operate button.

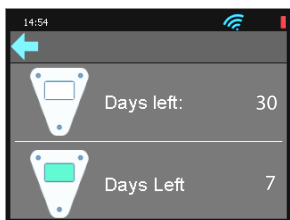

After calibration has been finished, the instrument indicates the days until next calibration is required.

Green check:

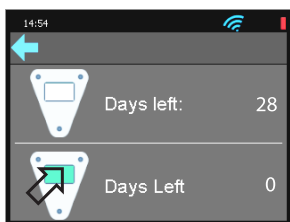

Click on the green tile symbol to perform green tile check.

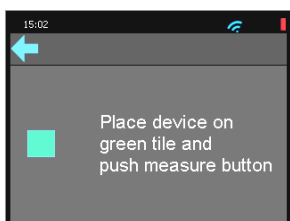

Place the instrument on the green standard and press the operate button.

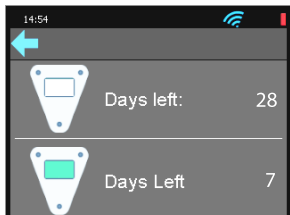

After the green check has been finished, the instrument indicates the days left until the next check is required.

7. Measurement techniques

In order to obtain accurate and repeatable measurements, the bottom of the instrument must be aligned flat on the surface to be measured. Do not move the instrument while measuring. This can cause the measurement values to vary.

Use the alignment marks on both sides of the instrument to center the measurement aperture over the desired area.

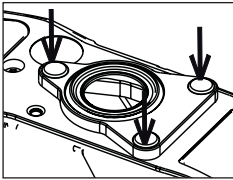

To perform a measurement, all three pins on the bottom must be completely pressed down while the operate button is pressed.

Alternatively, the instrument can be set-up to perform a measurement by just pressing the three pins (auto measure).

A measurement requires four readings to be taken around the repair area to complete one stored measurement.

The display will guide you through the readings.

7.1 Light protection ring

The measurement aperture of the instrument is surrounded by a light protection ring made out of rubber. It acts as a protection against ambient light. Keep the ring always clean and change it when being damaged (see section Cleaning and Maintenance). In case it leaves marks on the panel, clean the marks with water and soap.

7.2 Cleaning the Car

Clean Object = Clean measurements

Cleaning the area to be measured is essential. Any surface dirt, grease, scratches or dust already in the paint **WILL** influence the quality of the measurement. The surface must also be dry!

Do **NOT** measure sprayed panels without allowing sufficient time for the panel to dry.

Which polish?

Water and soap is good enough to remove the surface dirt. There are many different polishing products and the general guidelines are:

- Use a non silicon polish.
- The product must not be abrasive and leave any visual scratches or haze on the top coat.
- Avoid badly scratched areas, If you have no choice then start with a coarse polish and finish with a fine polish to achieve a satisfactory finish.
- Using a TACK RAG can also help to remove dust before measuring. Don't use a tack rag that has previously been used for a completely different color.

Polishing motion

Polishing always leaves very small scratches on the surface. To randomize these „micro“ scratches a rotating polishing motion is recommended. These scratches can have an effect on the measurement

depending on :

- The Color
- The coarseness of the polish
- The hardness of the top coat
- The condition of the cloth or rag being used to clean the car – avoid using a dirty cloth with different colors already on the cloth!
- The condition of the area to be measured – avoid road chips, etc.

To reduce the influence of scratches use the tools that you already have available.

Use the polishing machine, if not, then use a rotating motion. Check the area to make sure it is clean. Using a degreaser can also help to remove any residual grease.

8. Measurement

8.1 Measuring the vehicle

As you see from the previous chapter the surface is very important for good results.

Here are a few tips for successful use of the instrument.

Four **CORRECT** measurements are required to complete the process.

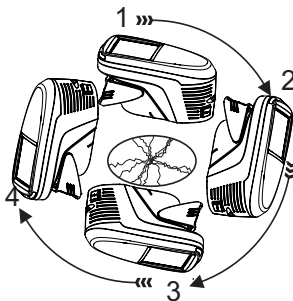

- Select a 'clean' area that is undamaged, free from scratches. Avoid imperfections in the paint like craters, drips, etc! Also avoid curved surfaces whenever possible.
- Measure as close as possible to the area being repaired. Also take measurements on both sides of the area, if possible.
- Turn the instrument 90° after each measurement.

8.2 Rotating during measurements

To optimize search results Automatchic Vision always averages 4 rotated measurements.

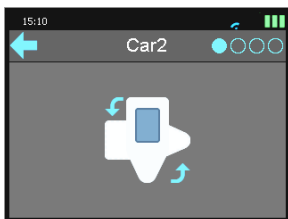

The measurement direction is explained to the user. Each rotation is shown on the instrument display and the user is instructed to point the instrument in a fixed direction and rotate the device in that way.

Rotating during measurements is important for metallics and pearls to minimize the various flip-tones. This also minimizes the effect of 'micro' scratches.

The Automatchic Vision remains a 'tool' which requires experience to get the best from it!

- When the surrounding temperature is high, place the car in the shade or inside the body shop to acclimatize.
- When the surrounding temperature is low, measure the bonnet of the car which has not yet cooled off. Of course a much better solution is to move the car into the body shop for acclimatization.

8.3 Measurement-Step-by-Step

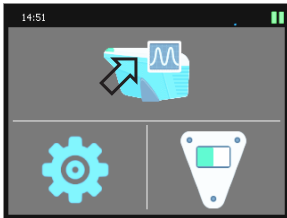

Press the instrument symbol on the display.



A work list is displayed containing default color sample names. The  checkmark is displayed when a reading is stored for the color sample.

If other color samples are required they need to be transferred from the AkzoNobel software to the instrument. Maximum 300 entries can be stored in the device.

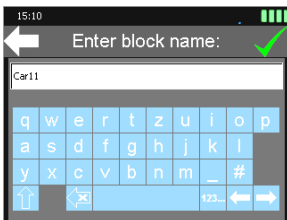

You can add a color sample to the list by clicking on the „plus“ sign. The input mask opens. Enter the name with the keyboard and add the color sample to the list by clicking on the checkmark.

Choose the appropriate color sample you want to measure and position the instrument.

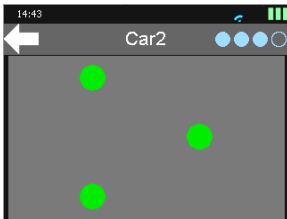

While positioning the instrument the display shows if the pins are pressed. Pressing operate starts the measurements. The measurement process is indicated in the display. One measurement consists of four readings. After each measurement the device should be lifted and rotated. When auto measurement function is ON, the reading is automatically executed when all pins are pressed.

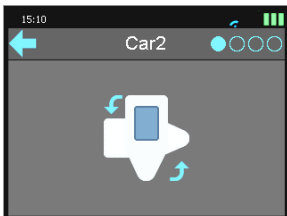

The number of readings is shown in the upper right corner of the display by filled circles.

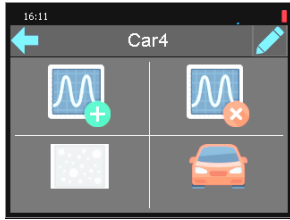

When the last reading is finished, data will be stored and the mask to add a car name or coarseness is displayed.

8.4 Add coarseness (optional)

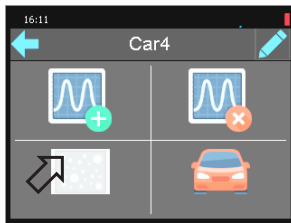

Having finished the measurement coarseness and/or car make can be added optionally. However this can also be done at the PC when performing a colorsearch.

Click on the coarseness scale.

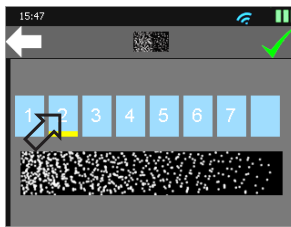

Choose coarseness by clicking on the respective number.

Subsequently a car make can be added.

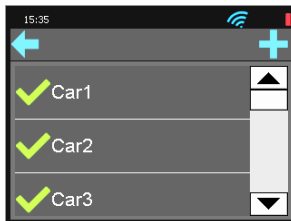

If you did not add coarseness immediately after the measurement you can still add it later.

By clicking on the instrument symbol, the work list is displayed.

All color samples with a leading checkmark indicate that a measurement is stored.

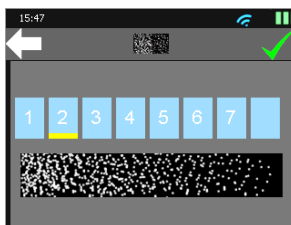

Choose the appropriate color sample by clicking on it.

Click on the coarseness scale and select the respective number.

Coarseness may also be added to the measurement in the AkzoNobel color retrieval software.

8.5 Add Car Make (optional)

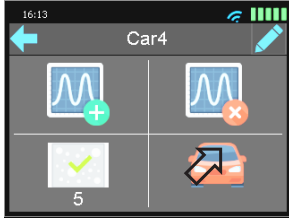

To add a car make, click on the car symbol in the display.

A selection menu appears, containing all car makes which are available in the instrument.



Choose the appropriate and then click on the checkmark to save it.

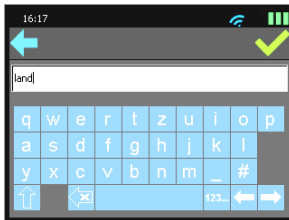

When you click on the magnifier symbol, a entry field opens where you can enter e.g. the first letters of the car make.



Then click on the checkmark and the car makes which contain these letters will be displayed. Click on the desired car make and then click on the checkmark to save it.

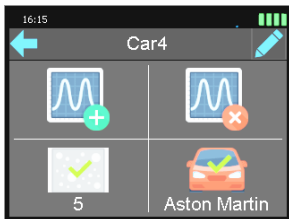

The instrument returns to the selection menu.

This car make list must first be sent to the device via the AkzoNobel color retrieval software. Car make may also be added to the measurement in the AkzoNobel color retrieval software.

8.6 Delete readings

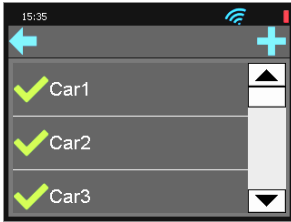

From the start screen select the instrument symbol. The work list appears. Choose the appropriate color sample from the list to be deleted.

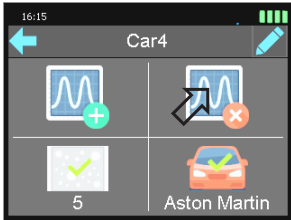

Click on the symbol "Delete Reading".

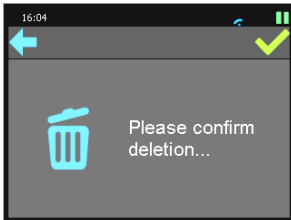

You are requested to confirm the deletion by clicking on the checkmark.

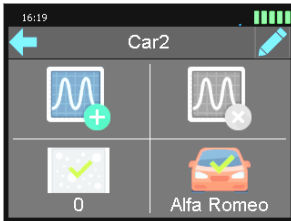

The instrument returns to the screen where you can enter a new measurement.

9 Setup



To enter the setup menu click on the settings icon.



The first screen appears with access to device info and WLAN settings.

To move to other setup parameters use the „forward“ and „backward“ arrows.

9.1 Device Info

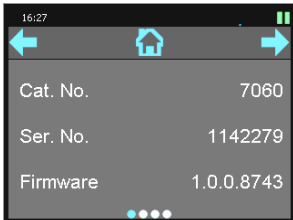

This menu displays the following information about the device:

- Catalog No.
- Serial No.
- Firmware Version



To proceed click on the „forward“ arrow, to go back, click on the „backward“ arrow.

- Date of last calibration
- Date of last green check

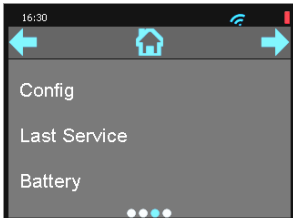

- Configuration
- Last service
- Battery status

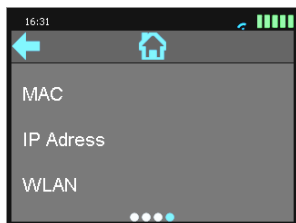

- MAC address of the instrument
- IP address within the WLAN
- WLAN information

9.2 WLAN settings

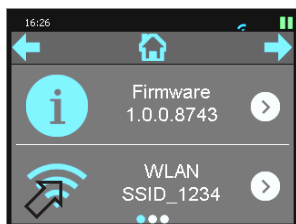

In the WLAN section the name of the WLAN is displayed. The WLAN can be altered and the password can be entered.

Click on the WLAN symbol to open the dialogue.

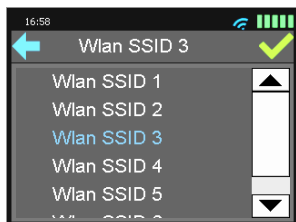

If you need to use another WLAN, choose it from the list and confirm by clicking on the checkmark.

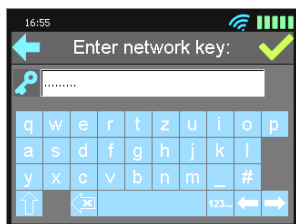

Enter the appropriate network key and confirm by clicking on the checkmark.

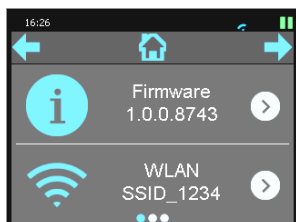

The instrument displays the new network information.

9.3 Auto measure

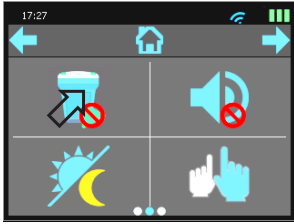

The instrument can be setup to execute a reading by just pressing the three pins.

The new status is indicated in the display:



Click again on the icon to reverse the status.

9.4 Beeper

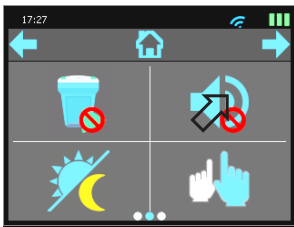

This menu option turns the beeper on or off. Click on the icon to turn the beeper on.

The new status is indicated in the display:



Click again on the icon to reverse the status.

9.5 Display background

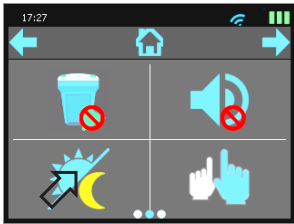

This menu option switches the background of the display from light to dark. Click on the icon to switch the display to light.

The new status is indicated in the display:



Click again on the icon to reverse the status.

9.6 Rotate display

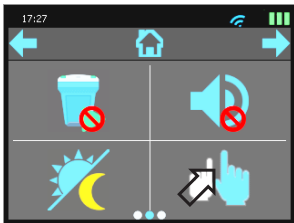

This menu option rotates the display for right / left handed operation.

The new status is indicated in the display:



Click again on the icon to reverse the status.

9.7 Language

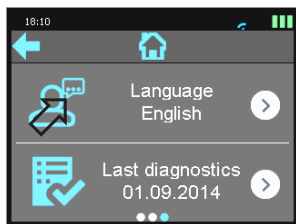

To choose a different language, click on the language symbol. A selection menu appears, containing all languages which are available in the instrument.

Click on the desired language to select it and then click on the checkmark to confirm the choice.

9.8 Run Diagnosis

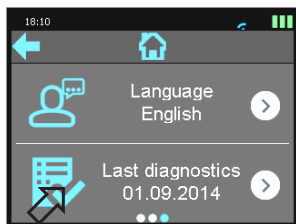

Click on the diagnosis symbol and the instrument carries out a self diagnosis. If no error is detected Diagnostic O.K. is displayed. In case of an error, Diagnostic check failed is displayed.

Please refer to Errors and Warning Messages in chapter 13.

10. Interface

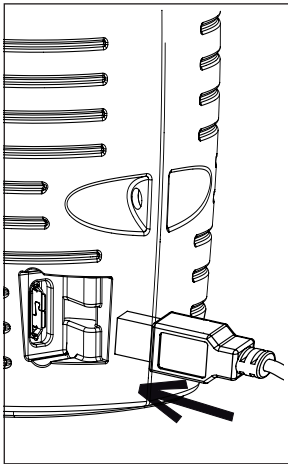

The measurement device is equipped with a micro USB interface that allows direct communication with a PC. The required USB cable is enclosed.

All readings are automatically saved and can be transferred to a computer with the AkzoNobel Color Retrieval Software.

11. Standards

DIN 5033	Colorimetry; basic concepts.
DIN 5036	Radiometric and photometric properties of materials; definitions characteristic.
DIN 6174	Colorimetric evaluation of colour differences of surface colours according to the CIELAB formula.
DIN 6175-2	Tolerances for automotive paints Part 2: Goniochromatic paints.
DIN EN ISO 11664	Colorimetry
ISO 7724	Paints and varnishes - Colorimetry.
ASTM D 2244	Standard Test Method for Calculation of Color Differences From Instrumentally Measured Color Coordinates.
ASTM E 308	Standard Practice for Computing the Colors of Objects by Using the CIE System.
ASTM E 1164	Standard Practice for Obtaining Spectrophotometric Data for Object-Color Evaluation.
ASTM E 2194	Standard Practice for Multiangle Color Measurement of Metal Flake Pigmented Materials.
SAE J 1545	Instrumental Color Difference Measurement for Exterior Finishes, Textiles and Colored Trim.

12. Technical Data

General technical data:

Temperature range	0 °C to +60 °C (32 °F to 140 °F) for storage +5 °C to +40 °C (41 °F to 104 °F) for operation
Rel. humidity	Up to 85% non-condensing/35°C (95 °F)

Measurement unit:

Geometry	Illumination 45° 25°, 45°, 110° aspecular viewing
Measurement aperture	10mm (0.40 in.)
Spectral range	400 - 700 nm
Spectral interval	10 nm
Repeatability	< 0.05 dE94-rms 10 consecutive readings on white tile
Inter-instrument agreement	BCRA solid tile set: dE94-rms < 0.15 BCRA solid tile set: dE94max = 0.39
Memory	300 samples
Akku operation	5V \equiv 1.5A; 2900 mAh; 10.4 Wh
Dimensions (LxWxH)	164 x 69 x 102mm (6.4 x 2.7 x 4.0 in.)
Weight	approx. 460g/ 0.92 lbs
Interface	Micro-USB-B

13. Errors and Warning Messages

Calibration failed!
Please retry.

Appears when white calibration failed for the first time.

Calibration failed!
Please clean white
calibration tile or
contact tech rep.

Appears when white calibration failed for the second time.

Green check failed!
Please retry.

Appears when green check failed for the first time.

Green check failed!
Please clean green
tile and retry.

Appears when green check failed for the second time.

Green check failed!
Please contact
tech rep.

Appears when green check failed for the third time.

Measure failed!
Please repeat...
Low battery

Battery too low. Instrument must be charged.

Measure failed!
Please repeat...
Pins not pressed

Appears when sensor pins are not pressed during a reading.

Measure failed!
Please repeat...
General

Appears when an internal error occurred during a reading.

Errors and Warning Messages

White check invalid! Please perform white check first.	Appears when doing a green check and the white calibration is expired.
White calibration or green check invalid or expired! Please calibrate now!	Appears when white calibration or green check are expired.
Surface temperature too high!	Sample surface temperature is too high.
Instrument temperature too high	Instrument temperature is higher than 40°C.
Instrument temperature too low	Instrument temperature is lower than 5°C.
Ambient light	Appears when ambient light enters the measurement aperture.
Keep instrument stable	Appears when instrument was moved during a reading.
Test failed!	Appears when one test of the complete diagnosis check failed.
Diagnostic check failed!	Appears when diagnosis check failed.
Reset	To perform a hardware reset, press the Operate button permanently for approx. 10 seconds. The reset can be done at any time.

15. Cleaning and Maintenance



- Do not insert any objects into the measurement aperture for cleaning. The instrument could get damaged.



- **Do not use any acetone or other aggressive or strong solvents for cleaning the unit!** The instrument housing is resistant to a number of solvents, but cannot be guaranteed to withstand all chemicals. You should therefore use a soft, moist cloth for cleaning. For cleaning excessive dirt, use ethanol or cleaning alcohol.



- Do not attempt to make any repairs yourself! If a malfunction occurs on your measuring device, our Customer Service department will be happy to help you as quickly as possible.

15.1 Cleaning standards



Do not use any acetone or other aggressive or strong solvents!

The accuracy of the measurement can be significantly impacted by using dirty or damaged standards.

Since the surfaces of the standards are highly sensitive, cleaning must be undertaken with great care.

To clean standards, use a new lint-free cloth, dust-free lens paper or an optical cloth.

Apply only slight pressure as you clean and make certain there are no large particles stuck in the cloth that could damage the surface.

For dirt that is difficult to remove, use an optical cloth dipped in liquid. Then wipe the surface with a dry optical cloth.

It is highly recommended to handle the standards with great care. They should always be stored enclosed.

15.2 Light protection ring

Cleaning:

You should use a soft, moist cloth for cleaning. For cleaning excessive dirt, use ethanol, cleaning alcohol or water and soap.

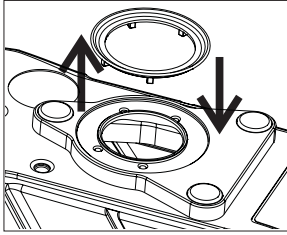

Changing:

Remove the worn down ring with a pointed object. To insert the new ring, bend its inner edge slightly upward before you insert it into the groove.

16. Copyright

This instruction manual is an important part of this instrument. It contains essential information about setting up, placing in service and use. If you pass the device on to another user, please ensure that the instruction manual is included with the instrument. The manual must be studied carefully before working with the equipment. Please contact your regional service office if you have any questions or require additional information about the device.

The technology and fittings are based on state-of-the art optic and electronic technology. New developments and innovations are constantly being integrated into the equipment. Thus, the diagrams, dimensions, and technical data used in this manual may have changed as a result of adapting the device to new information and improvements.

© Copyright 2014 BYK-Gardner GmbH
All rights reserved

No portion of the software, documentation or other accompanying materials may be translated, modified, reproduced, copied or otherwise duplicated (with the exception of a backup copy), or distributed to a third party, without prior written authorization from BYK-Gardner GmbH. In any case, this requires the prior written consent of BYK-Gardner.

BYK-Gardner GmbH offers no guarantee that the software will function without error or that the functions incorporated therein can be executed in all applications and combinations selected by you.

No liability other than as provided by law is assumed for direct or indirect damage sustained in association with the use of the instrument, the software or documentation.

BYK-Gardner GmbH reserves the right to update the software and written documentation without prior notice.

275 023 070 E 1409